

Guidelines For The Installation Of Wireless Technology In Buildings

Introduction

Due to the use of wireless technology in the transmission of sensor measuring values and the cessation of simple electrical cable couplings between sensor and evaluation unit, there are some basic guidelines that must be followed during planning and installation.

These information shall help both, the planner with regard to the integration of the radio path and the system integrator/engineer or service technician during installation or in case of a malfunction.

Basics For Radio Signals In Buildings

Radio signals are electromagnetic waves, which are damped on their way from the transmitter to the receiver.

Both, the electrical as well as the magnetic field strength is removed inversely proportional to the square of the distance between transmitter and receiver ($E, H \sim 1/r^2$).

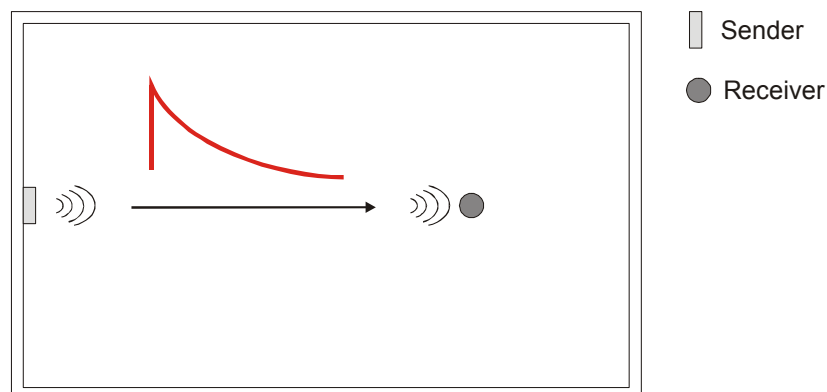

Picture: Course of field strength

Reflection and Transmission

Beside these natural transmission range limits, further interferences have to be considered: metallic parts, e.g. reinforcements in walls, metallized foils of thermal insulations or metallized heat-absorbing glass, reflecting electromagnetic waves. Thus, a so-called radio shadow is produced behind.

It is true, that radio waves can penetrate walls, but thereby the damping attenuation is even more increased than by a propagation in the free field.

Here are some examples for different types of walls:

Material	Penetration
Wood, gypsum, uncoated glass without metal	90...100%
Brick, pressboard	65...95%
Reinforced concrete with iron reinforcement	10...90%
Metal, aluminium pasting	0...10%

For praxis, this means that the building material used in a building is of paramount importance for the evaluation of the transmitting range. For an evaluation of the environment, some standard values are listed:

Visual contacts:	Typ. 30m range in passages, corridors, up to 100m in halls
Rigypsum wall/wood:	Typ. 25m range through max. 4 walls
Brick wall/gas concrete:	Typ. 15m range through max. 2 walls
Reinforced concrete walls/ceilings:	Typ. 10m range through max. 1 wall/ceiling

Notice: Supply areas and lift shafts should be seen as a screening.

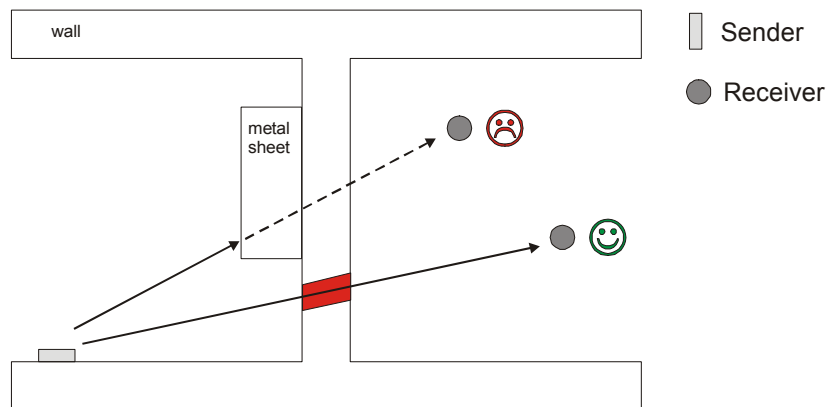

Picture: Screening of radio wave

In addition, the angle with which the signal sent arrives at the wall is of great importance. Depending on the angle, the effective wall strength and thus the damping attenuation of the signal changes. If possible, the signals shall run vertically through the walling. Walling recesses should be avoided.

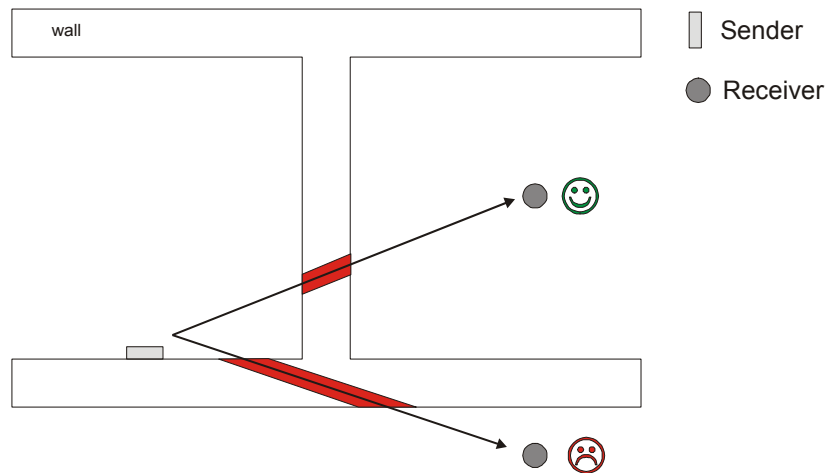

Picture: Course of radio wave

Mounting Of Receiving Antenna

The ideal mounting place of an external receiving antenna is a central place in the room. If possible, the antenna should have a distance of min. 0,1m (min. $\lambda/4$, example: with 868MHz \approx 9cm) to the wall and 0,5m from the ceiling. Due to the polarization of the antenna, the antenna shall be aligned downwards or upwards. In order to get a sufficient counterbalance with an unilateral dipole, the antenna shall be mounted to a ferro magnetic metal board with dimensions min. 180x180mm (with 868MHz). When laying the antenna cable watch that the cable is not bended (change of wave resistance -> reflection on the line).

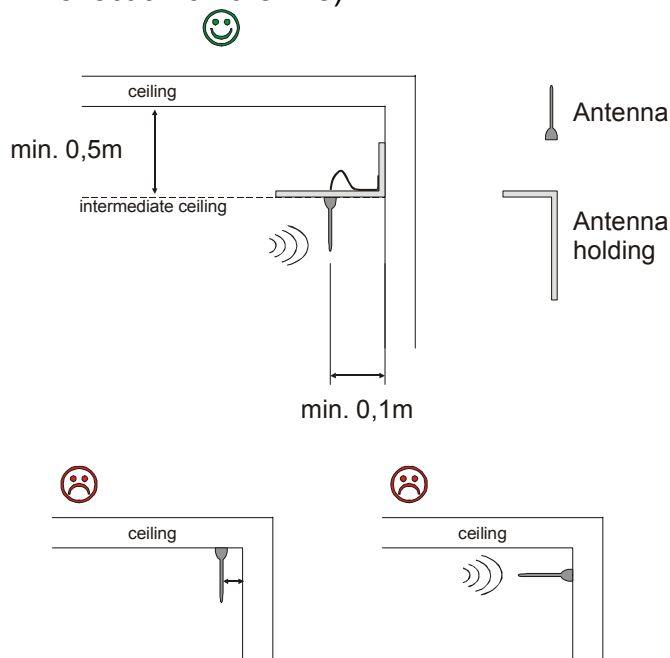

Picture: Antenna in ceiling area

As for devices with an inside receiving antenna, the mounting place shall not be at the same wall side as the transmitter. In the wall area, radio waves are rather subject to an interfering leak or reflection. The opposite or following wall is better.

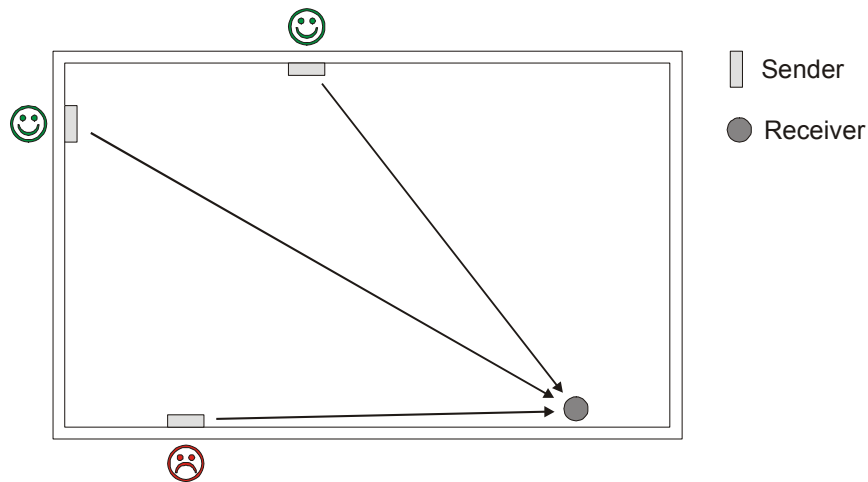

Picture: Radio wave at the wall

Distance To Other Interference Sources

The distance to other transmitters (e.g. GSM / DECT / Wireless LAN / EnOcean Transmitters) shall at least amount to 2m.

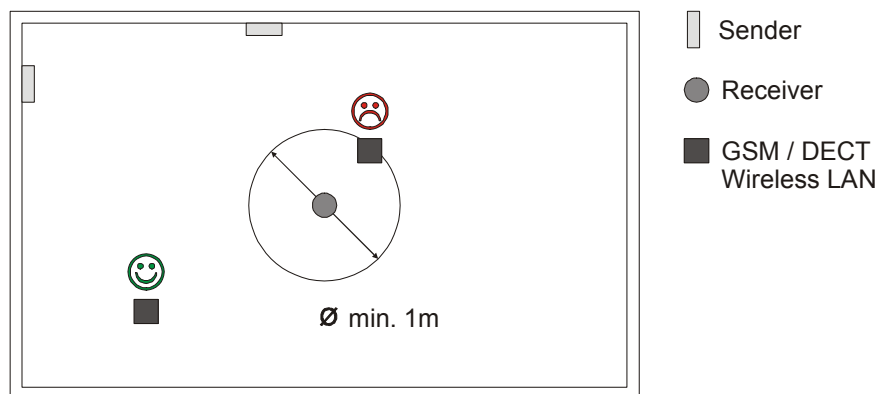

Picture: Distance to interference sources

Use of Repeaters

If there are some problems with the detection range of the radio receivers, the use of a repeater could be helpful.

Tip: The additional use of repeaters should be taken in consideration, when planing a wireless installation.

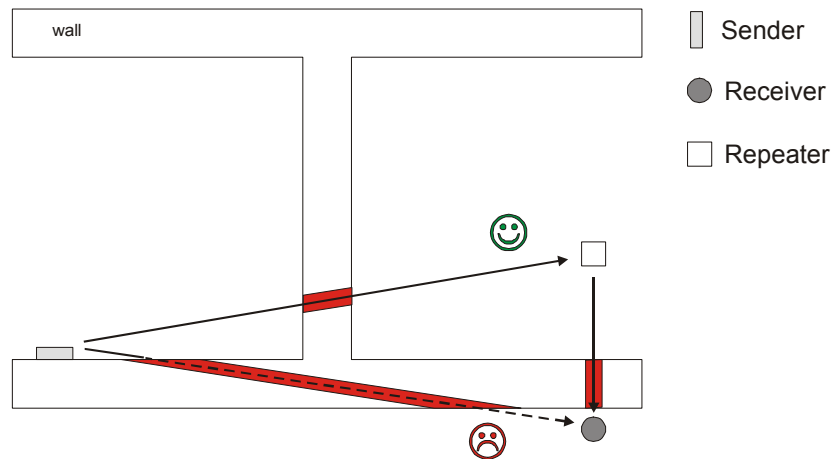
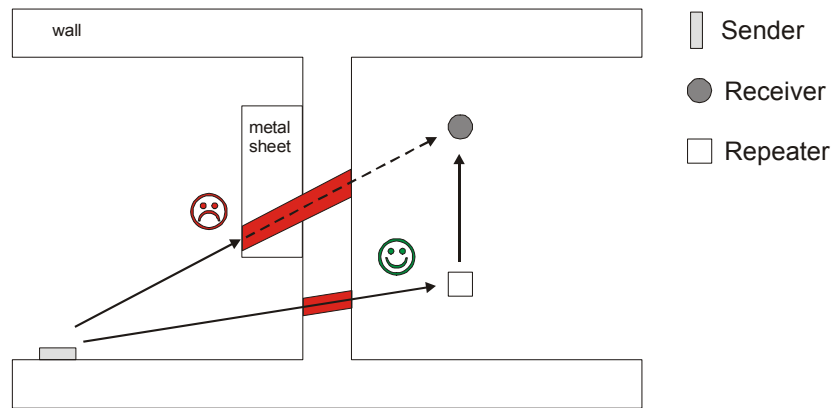

Picture: Use of Repeaters

Field Strength Measuring Instrument EPM100

The EPM100 is a mobile field strength measuring instrument which enables the electrician to easily determine the optimum mounting place for sensor and receiver. Moreover, it can be used for the examination of interfered connections of devices, already installed. At the device, the field strengths of radio telegrams received or interfered radio signals in the range 868MHz are displayed. For further information, please see the operating instruction of the EMP100.

Procedure for finding the optimum positioning of wireless transmitters and receivers:
 Person 1 operates the radio sensor and generates a radio telegram by bushbotton actuation

Person 2 checks the received field intensity on the meter display and determines the optimum mounting position.

Right Mounting Place Of Radio Sensors Operating With Solar Cell

Just like you have to observe certain basic conditions when dealing with the planning of solar radio sensors due to the propagation of radio waves, you have to meet special requirements concerning a correct and sufficient ambient brightness when selecting the mounting place.

By means of the energy-optimized EnOcean radio technology used in our "EasySens" radio sensors, supplying themselves with electric energy by a 2 cm² solar cell, the devices can work without batteries. Thanks to the cessation of changeable batteries the sensors are almost maintenance-free and environmentally sound.

If necessary, the solar-powered energy storage must be reloaded after a longer storage of the radio sensors in darkness, e.g. during installation. In principle, however, this is made automatically during the first operating hours in daylight. If the initial loading should not be sufficient in the first operating hours, the sensor is reaching its full operating state after 3 to 4 days at the latest. The sensor is sending properly in darkness (in the night) after this period of time at the very latest.

When selecting the mounting place for the radio sensors, the following should be considered:

- The minimum illumination of 150lx should be guaranteed at the mounting place for at least to 3-4 hours everyday – regardless whether there is artificial light or daylight. The health and safety at work act requires a minimum illumination of 500lx for office workplaces.
- Direct sunlight should be avoided
- A recess that is not illuminated sufficiently in the course of a day should be avoided.
- When using collimated artificial light the angle of incidence on the solar cell should be not too steep.
- The sensors should preferably be mounted with the solar cell in window direction, whereas a direct sun radiation should be avoided. An occasionally direct sun radiation would lead to falsified measuring values with the temperature detection.
- With regard to a future use of the room, the mounting place should be selected in that way, that a later shadowing by the user, e.g. by filing places or rolling container, is avoided.

Luxmeter

The following table is showing typ. values of light conditions in different buildings. These values are helpful for planning the installation places of a solar-powered sensor. To verify the values a simple luxmeter can be used (possible distributor for Luxmeter: Conrad Elektronik, Luxmeter MS-1300, order no. 128800-62, approx. price 35€).

When measuring the lux level it is important that the luxmeter has a good accuracy (typ. ±10Lux) and the measuring place is the installation place of the sensor.

Illumination Area	Type Destination / Workspace	Typical Brightness
Home	Living room	100 – 500 lx
Schools	Writing at the board	500 – 1000 lx
	Corridor	100 – 300 lx
	Classroom in general	300 – 500 lx
	Reading room	500 – 1000 lx
	PC room, working at PC	200 – 500 lx
Offices	Meeting room	300 – 700 lx
	Canteen	150 – 300 lx
	Corridors	50 – 100 lx
	Reception	300 – 700 lx
	Restroom	100 – 300 lx
	Factories	Production hall
Development, office		300 – 750 lx
Design CAD		500 – 1000 lx
Laboratory work		500 – 1500 lx
Packaging of products		300 – 700 lx
Storage		100 – 300 lx
Hospitals	Visitor room	300 – 500 lx
	Educational work	300 – 700 lx
	First aid, surgery	500 – 1500 lx
	Bedroom	100 – 300 lx
	Pharmacies	500 – 1000 lx
	Wash rooms	150 – 300 lx
Hotels	Reception	300 – 700 lx
	Entrance area	100 – 300 lx
	Restaurant	150 – 300 lx
	Restroom	100 – 300 lx
	Bars	50 – 150 lx
	Corridors	50 – 100 lx
	Staircases	50 – 150 lx
Stores	Saleroom	300 – 1000 lx
	Show room	300 – 1500 lx
	Packaging area	200 – 300 lx
	Lounge	300 – 500 lx
	Conference room	300 – 700 lx
Trade Show	Booth	300 – 500 lx
Sports Arena	Indoor area	200 – 500 lx

Table: Typical expected light conditions

Important Advice for Measuring the Right Lux-Level:

Please note that the values could vary between center of the room and wall (see following picture).

Depending on the used lights, material, conditions, the lux-level inside a room could vary extremly. Therefore the absolute values of the lux-level are only examples for practical use. It is important, that the expected lux-level is verified after installation of the sensor.

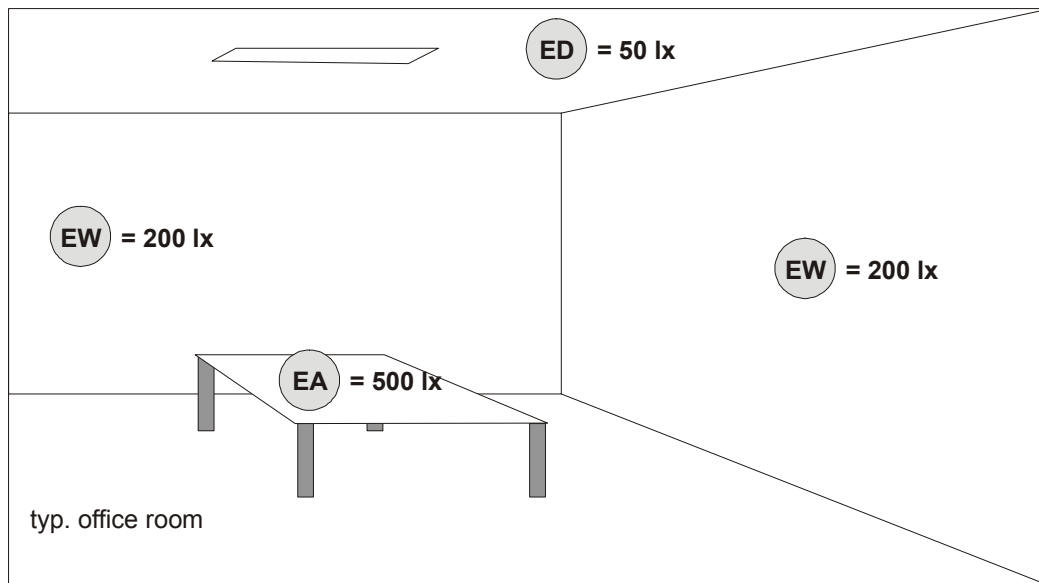

Picture: Example of a typ. office room with light intensity of 500lx

Troubleshooting

By paying attention to the above instructions and notices for finding the best mounting position of transmitter and receiver, an interference-free operation of the devices shall be guaranteed. Should there be some transmission problems nevertheless, the following table of malfunctions shall serve as a first measure:

Error	Possible Cause	Measure
Sensor is not sending	Empty energy-storage	Solar Sensor: Ensure light intensity >150lx for 3-4 hours a day. After 3-4 days the sensor has reached its full readiness for operation and also sends in the dark. Probably change solar sensor to battery-powered sensor. Battery Sensor: Test battery, change battery
	Energy storage is not loaded sufficiently during installation.	Load energy storage of sensor (2 hours with 1000Lux): e.q. put the sensor for 2 hours on a sun lighted window seat.
Sensor stops sending after some time.	Energy storage is not loaded sufficiently.	Solar Sensor: Ensure light intensity >150lx for 3-4 hours a day. Probably change solar sensor to battery-powered sensor. Check jumper, adjust higher sending

		intervals
	Energy storage was not loaded sufficiently during installation.	Load energy storage of sensor (2 hours with 1000Lux): e.g. put the sensor for 2 hours on a sun lighted window seat.
Sensor stops sending during the night and starts sending again in the morning.	Energy storage is not loaded sufficiently during the day.	Solar Sensor: Ensure light intensity >150lx for 3-4 hours a day. Probably change solar sensor to battery-powered sensor Check jumper, adjust higher sending intervals
	Energy storage is not loaded sufficiently during the day.	Solar Sensor: Ensure light intensity >150lx for 3-4 hours a day. After 3-4 days the sensor has reached its full readiness for operation and also sends in the dark.
Sensor is not received. Receiving LED at the receiver does not shine.	Sensor is not sending.	Check sensor as described above.
	Sensor is mounted outside the receiving range of the receiver.	Change mounting place of sender or antenna. Note the transmission range and mounting advices in the data sheet.
	Wrong connection of antenna.	Check the laying of the antenna cable. Note the mounting advices in the data sheet.
	Sensor is not learned-in.	Renewed learning-in of sensor via the "learn mode" at the receiver.
	Wrong sensor learned-in.	Renewed learning-in of sensor via the "learn mode" at the receiver.
	Sensor removed.	Renewed learning-in of sensor via the "learn mode" at the receiver.
Sensor is not received at the receiver from time to time.	The mounting place of the sensor is change occassionally.	Move mounting place of sender into the receiving range.
	Occasionally change of ambient conditions (cupboard, door, plants, people, jammer)	Check distance to interference source. Minimum 0,5m. Probably shift sensor or external antenna of receiver. Probably use an additional repeater
	Distance between sender and receiver reaches its limits.	Probably shift sensor or external antenna of receiver. Probably use an additional repeater
Wrong evaluation of sensor	Wrong adjustment of	Check configuration of receiver. See

	parameter at the receiver (e.g. wrong measuring range)	software description of the respective receiver.
--	---	--

Issue 31.07.06 – Dirk Debus